

Using your BrilliantSmart app you can turn this device ON/OFF. Each touch switch can be controlled individually. See over for voice control.



4 gang switch shown

8. If unsuccessful click '**How to make light blink rapidly**' and follow the steps.

If still unsuccessful turn off the power to the smart device, wait for 30 seconds, then try again.

Multiple Wall Switches

Multiple units can be added at once (ie by room) but they then need to be identified once connected. This can be done by turning them off and on (via app) and renaming the device name accordingly.



Voice Control

To integrate with Amazon Alexa or Google Assistant devices Open the BrilliantSmart app press '**Profile**' then '**Settings**' then '**Integration**'.

Click on Amazon Alexa or Google Assistant and follow the steps.

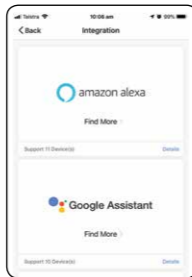

BrilliantSmart App Assistance

For BrilliantSmart app assistance click Profile then FAQ. This should answer any queries you have.

If this doesn't solve your problem then click '**Customer Service**', select '**New**' and click on the device then type in your query.

You should receive a response within 24 hours.

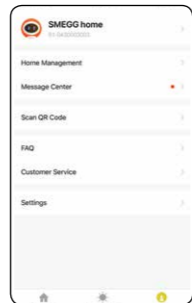

For further troubleshooting or to connect via AP Mode go to www.brilliantsmart.com.au.

Other BrilliantSmart functions

Timer & Schedule function

Click to set ON/OFF time.

Manual Override

The touch switch can be used to manually turn ON/OFF power to the load/s.

Device Reset

To reset, hold down one of the power buttons for seven seconds. Device is ready to setup again.

Power Metering Function

Electric stats

This allows you to monitor the power usage of connected loads (current, power, voltage and kWh).

The values shown are the total of all gangs per wall plate. These values are for reference only.

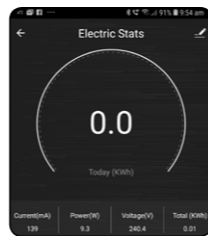

Warranty

Brilliant Lighting warrants this product against defects in manufacture and workmanship for a period of 2 years from date of purchase. Warranty does not include damage or loss arising from incorrect installation, operation or maintenance of this product, damage caused through modification, or incorrect installation.

Our goods come with guarantees that cannot be excluded under the Australian Consumer Law. You are entitled to a replacement or refund for a major failure and compensation for any other reasonably foreseeable loss or damage. You are also entitled to have the goods repaired or replaced if goods fail to be of acceptable quality and the failure does not amount to a major failure.

Any claim under this warranty must be made within 2 years of the date of purchase of the product.

Refer to our website brilliantlighting.com.au for terms and conditions and warranty claims.

This warranty is given by:

Brilliant Lighting (Aust) Pty. Ltd.
 ABN 37 006 203 694
 956 Stud Road Rowville, VIC 3178
 Phone: 03 9765 2555
 Email: warranty@brilliantlighting.com.au

MADE IN CHINA

Warning

1. To prevent injury, this apparatus must be installed by a Licensed Electrical Contractor.
2. For indoor use only.
3. Please make sure the smart glass switch is not overloaded. Working power cannot be higher than the rated power (100W LED, 500W Incandescent)
4. Do not attempt to press touch switch at very high frequencies (faster than one switch per second) as this may result in premature failure.

Brilliant Lighting
 956 Stud Road
 Rowville Vic 3178 Australia

www.brilliantlighting.com.au

Australian Sales
 T 03 9765 2555
 T 1800 817 754 (interstate only)
 F 03 9763 0277
 E sales@brilliantlighting.com.au

New Zealand Sales
 T 09 974 9618
 E sales@brilliantlighting.com.au



WiFi Glass Wall Switch



20681/05, 20683/05
 20685/05, 20687/05



USER MANUAL

Box content

Smart Glass Switch x 1
User Manual x 1

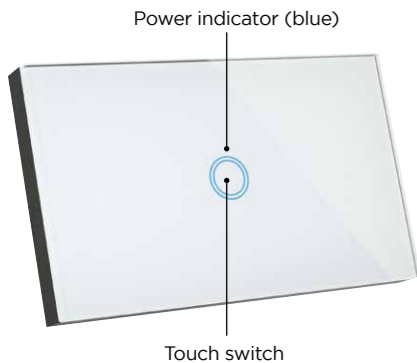

Technical Specifications

Model Numbers: 20681/05, 20683/05,
20685/05, 20687/05

Colour: White

Supply voltage: 240V AC 50Hz

Max. load: 500W Incandescent or 100W LED per gang

TA: 0...+35°C

Security: Mac Encryption; WEP/WAPI/TKIP/AES

WiFi Standard: IEEE802.11b/g/n

System Req's: iOS 8.0 or higher, Android 4.1 or higher

Installation

THIS FITTING MUST BE INSTALLED BY A QUALIFIED ELECTRICAL CONTRACTOR in accordance with the latest AS/NZS 3000 and relevant amendments

Important Safety Issues

Ensure the power is disconnected before installing. This product is NOT suitable for damp or explosive environments. Modification of this product will void any warranty. Indoor use only. Do not cover in insulation.

Product Features

- Three wire design (neutral required).
- Class II Construction.

Installation

The smart glass wall switches are designed to fit standard wall switch cutouts, and plaster/stud brackets with 84mm centres.

Remove the front glass by inserting a flat blade screwdriver into the recess on the side of the switch, twist and remove.

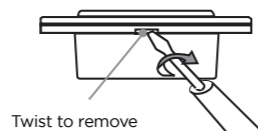

Connect the active incoming supply to L and N and earth using the 20mm² terminals.

Wiring Diagram

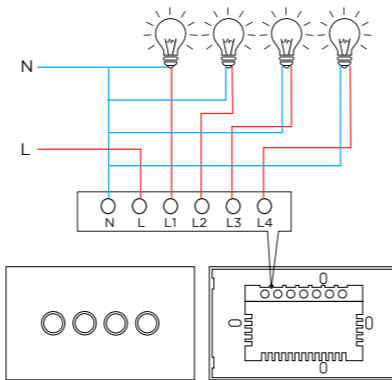

Insert the smart glass wall switch onto the wall, aligning the 84mm mounting holes with the plaster/stud bracket holes.

Tighten the mounting screws and replace the cover by clipping on one side followed by the opening side last.

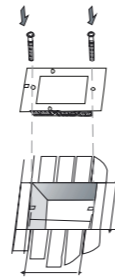

Connect to your WiFi

Ensure your mobile phone is connected to your 2.4GHz WiFi network.

Your mobile phone and your smart device needs to be within good signal strength range of your WiFi router. (Refer to your router specifications for max range.)

Download the BrilliantSmart App

Please download the free BrilliantSmart app from the App store or Google Play store, or scan the QR code below.

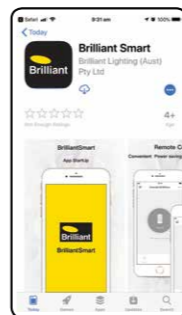

Register the BrilliantSmart App

Open the BrilliantSmart app.

For new users, register a new account or if existing user, login with your user name and password.

Configure your BrilliantSmart App

Setting up your Home

You can setup multiple homes or locations. Click 'Add Home' button. Or click on 'Home' top left if you are adding or modifying details then 'Home Management' to setup your home(s), add or rename rooms and share devices.

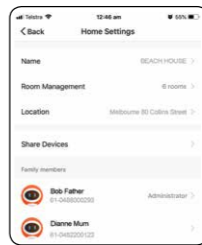

Add your Smart Device to your App

1. Arrange installation of your smart glass wall switch by a Licensed Electrical Contractor (refer installation instructions at start of this manual).
2. Once safely wired and powered on, hold the power button for 5 seconds until you hear a click sound, then release the button. All power indicator buttons should blink rapidly (2 times per second).
3. Open the BrilliantSmart App, tap 'Add Device' (if empty room) or '+' to add your smart power outlet.
4. Select 'Electrical Outlet' in the list of devices.

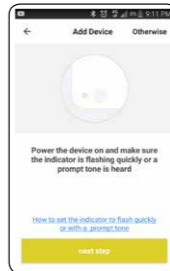

If the power indicator button(s) are blinking rapidly then press 'Confirm indicator rapidly blink'.

5. Enter your WiFi password.

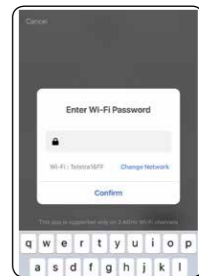

Connection will now begin.

6. Once connected you'll get a menu 'Adding device succeeded'.

Select the room device and press 'Done'.

You can click on the pen to change the device name. (each switch can have it's own name).

7. The smart device can now be controlled by the BrilliantSmart app.

